

An aerial photograph of Virginia Beach, Virginia, taken at sunset. The sky is a mix of orange, yellow, and blue. In the center, a tall, modern skyscraper with a pointed top is illuminated. To its right, a large, multi-story building with a prominent tower is also lit up. The city is densely packed with buildings, parking lots, and roads. The foreground is dominated by a large teal rectangular overlay that contains the title and subtitle text.

# VBDA Monthly Cash Flow

City of Virginia Beach Development Authority

February 21, 2023

# Operating Account Summary: January 2023

**Beginning Cash – January 1, 2023**

**\$ 2,835,601**

## **Significant Cash Receipts**

- **Grand Total of Significant Cash Receipts - \$743,970**
  - ✓ **\$349,395** Atlantic Park/Dome Site Reimbursement from City
  - ✓ **\$ 87,350** Westminster Canterbury – Annual Industrial Bond Administration Fee
  - ✓ **\$ 28,510** Cherry Bekaert – Reimbursement for FY21 Annual Audit
  - ✓ **\$251,397** Atlantic Park/Dome Site Reimbursement from City
  - ✓ **\$ 12,960** Corporate Landing Infrastructure-Reimbursable Nutrient Credit Purchase for Pond D
  - ✓ **\$ 14,358** Interest Income

# Cont. Operating Account Summary: January 2023

## Significant Cash Disbursements

- **Grand Total of Significant Cash Disbursements - \$1,021,557**
  - ✓ **\$ 63,499** Kimley Horn – Survey, Geotech, E&S work and due diligence studies for Innovation Park Phase 2
  - ✓ **\$ 12,960** Corporate Landing Infrastructure – Reimbursement for Nutrient Credit Purchase for Pond D
  - ✓ **\$ 70,652** Singer Davis -Atlantic Park (Dome Site) Project Legal Services
  - ✓ **\$ 31,342** Hunton Andrews Kruth - Atlantic Park (Dome Site) Project Legal Services
  - ✓ **\$ 1,750** Commissioner Stipends for 2<sup>nd</sup> Half of FY22
  - ✓ **\$ 4,258** WPL- Reimbursable Expense for Dome Site Project
  - ✓ **\$ 31,000** Kimley Horn – Reimbursable Expense for Dome Site Project
  - ✓ **\$ 14,205** Globalinx – Monthly Conduit Management Charge- February 2023

# Cont. Operating Account Summary: January 2023

## Cont. Significant Cash Disbursements

- ✓ \$ **8,875** KH-CN Partners – Project Coordination and Management for Phase I  
ESA Atlantic Park
- ✓ \$ **2,960** Venure On-Site GMP Cost Validation-Dome Site Project- Reimbursable
- ✓ \$ **13,125** Corporate Landing Stormwater – Design Southwest and  
Northeast Atlantic Park
- ✓ \$ **5,056** Lishelle Place Facility Assessment and Feasibility Study
- ✓ \$ **14,203** Vanasse Hangen Brustlin, Inc.- Corporate Landing New Roadway Design,  
Human Service Roof Replacement and Miller Group Parcel Survey
- ✓ \$ **6,400** Cherry Bekaert-Annual Audit for June 30, 2022
- ✓ \$ **\$694,392** Live Nation Worldwide, Inc. – Amphitheater Roof Replacement-Reimbursable

# Cont. Operating Account Summary: January 2023

## Cont. Significant Cash Disbursements

- ✓ **\$ 46,880** Live Nation Marketing, Inc. – 2023 Veterans United Amp Season (4 Parking Passes and 8 Tickets)

---

**Ending Cash – January 31, 2023**

**\$ 2,555,491**

# Incentive & Initiative Account Summary: January 2023

**Beginning Cash – January 1, 2023** **\$2,656,485**

## Significant Cash Receipts

**Grand Total of Significant Cash Receipts - \$481**

- ✓ \$ 481 Bank interest income

## Significant Cash Disbursements

• **Grand Total of Significant Cash Disbursements - \$10,923**

- ✓ \$ 10,923 Olympia Bendix-Two – Bio Accelerator Monthly Rent – January 2023

---

**Ending Cash – January 31, 2023** **\$2,645,647**

# EDIP Grant Summary Reporting: January 2023

<b>Beginning VBDA EDIP Grant Balance</b>	<b>\$3,656,689</b>
<b>Earned Interest and Activity Analysis Fee</b>	<b>+\$ 39</b>
<b>EDIP Grants Expired (Closed)</b>	<b>+\$ 79,043</b>
<b>New Grants Approved by VBDA</b>	<b><u>- \$ 140,000</u></b>
<b>EDIP Grant Funds Available as of Jan. 2023</b>	<b>\$3,595,771</b>

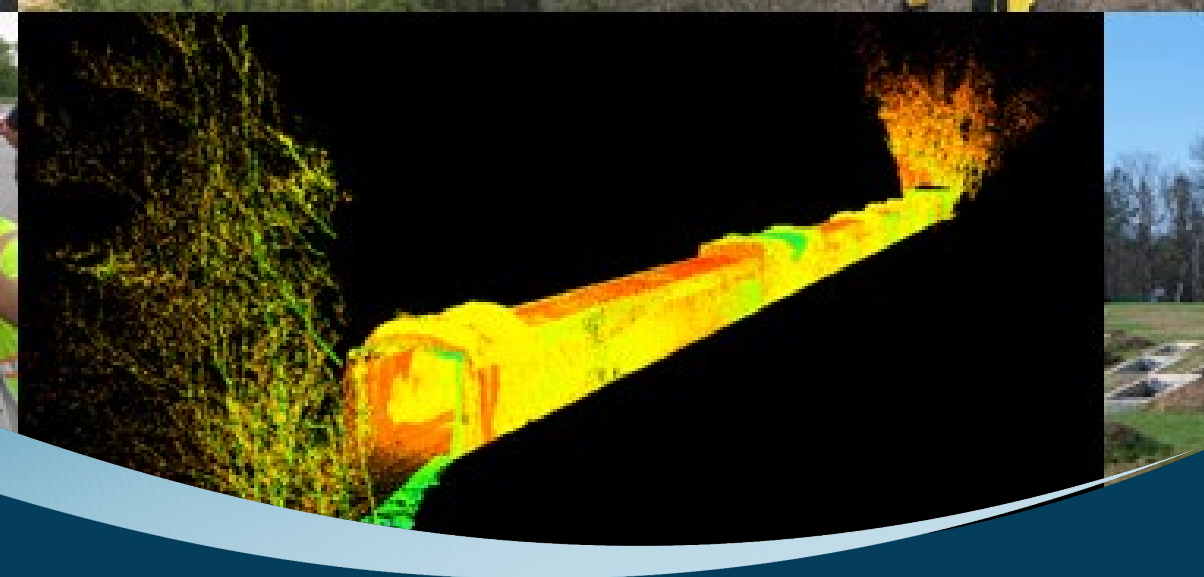

# Precision Measurements, Inc. Construction Design

Emily Archer, PLA, Economic Development Project Coordinator  
Virginia Beach Development Authority Open Session, February 21, 2023



# Disclosures

- *Applicant:* Precision Measurements Inc. (PMI)
- *Members:* Alexandra Leitz (representative), Pauline Leitz, Kenneth Leitz, Stephen Pearce
- *Accounting:* Cherry Bekaert, LLP, Barb Smith, CPA
- *Construction Contractor:* Hoy Construction, Adam Ritt
- *Architect/Land Planner:* Covington Hendrix Architects, Jonathan Covington, AIA
- *Engineering:* Land Planning Solutions, Scott D. Stam, PE
- *Financing:* C&F Mortgage
- *Legal Services:* Sykes, Bourdon, Ahern & Levy, P.C.

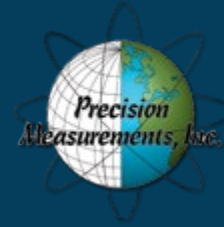

**Precision  
Measurements, Inc.**

# About the Company

- Established In 1995, (4) locations in Virginia + (1) in Maryland and (1) in Florida
- Employees 31
- PMI is a full-service land surveying firm with mapping, boundary surveys, platting, topographic surveys, 3-D scanning, route surveys, global positioning system surveys, construction stakeout, land title surveys, hydrographic surveys, and utility designation capabilities

# Location – Corporate Landing Business Park





# Sale Terms Recap

- Total Investment: \$10.1M
- Existing Jobs: 32
- New Jobs: 20
- \$200K per usable acre (2.9 usable acres)
  - Minus the cost of two streetlights and subdivision plat @ \$15,700
  - Total estimated land sale proceeds = **\$564,300**

# PMI Construction Design

- 3.5 acre site zoned I-1
- 16,000 SF total floor area for office and garage use
- 53 parking spaces
- One story brick structure
- All required setbacks met

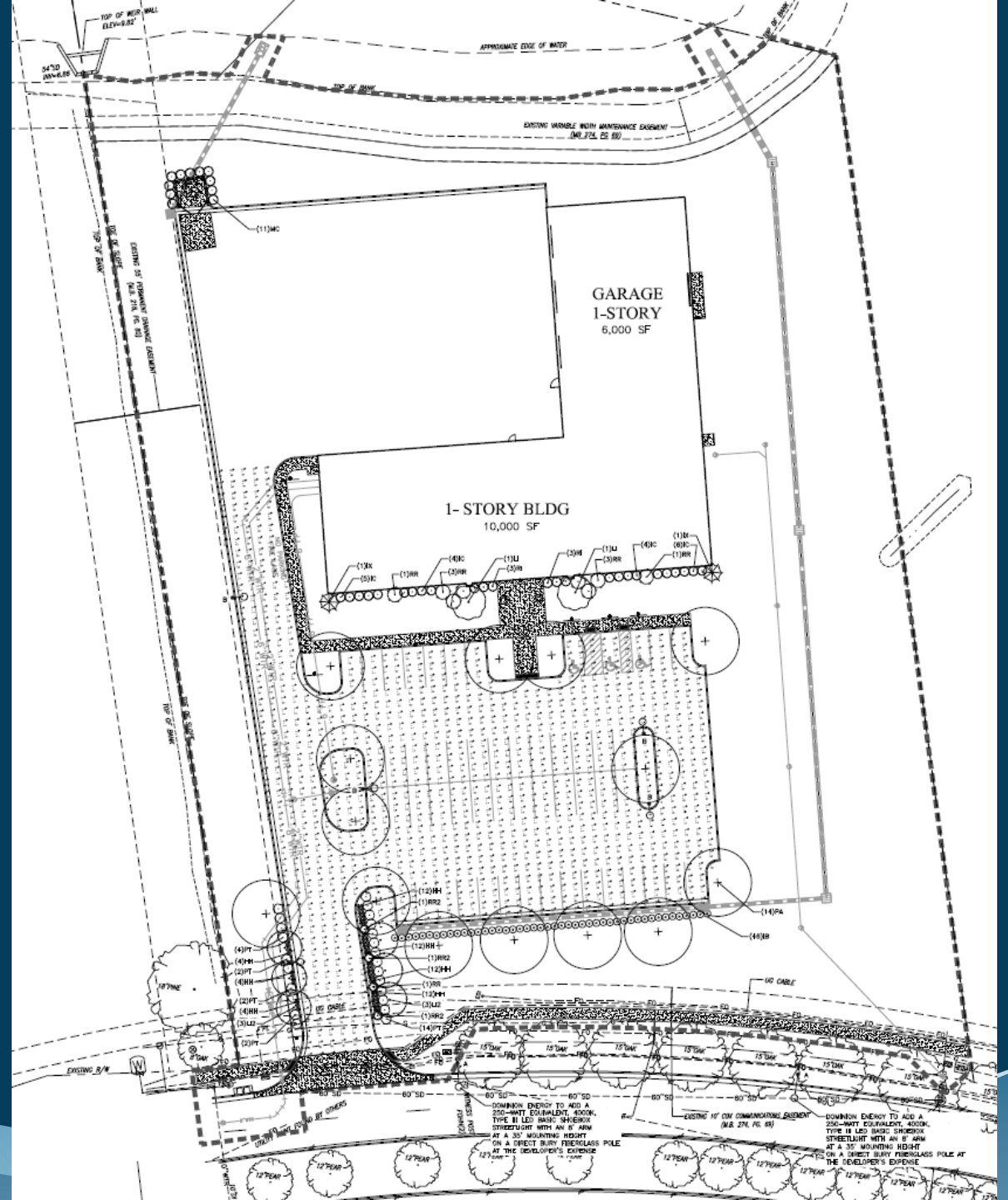

# PMI Floor Plan & Details

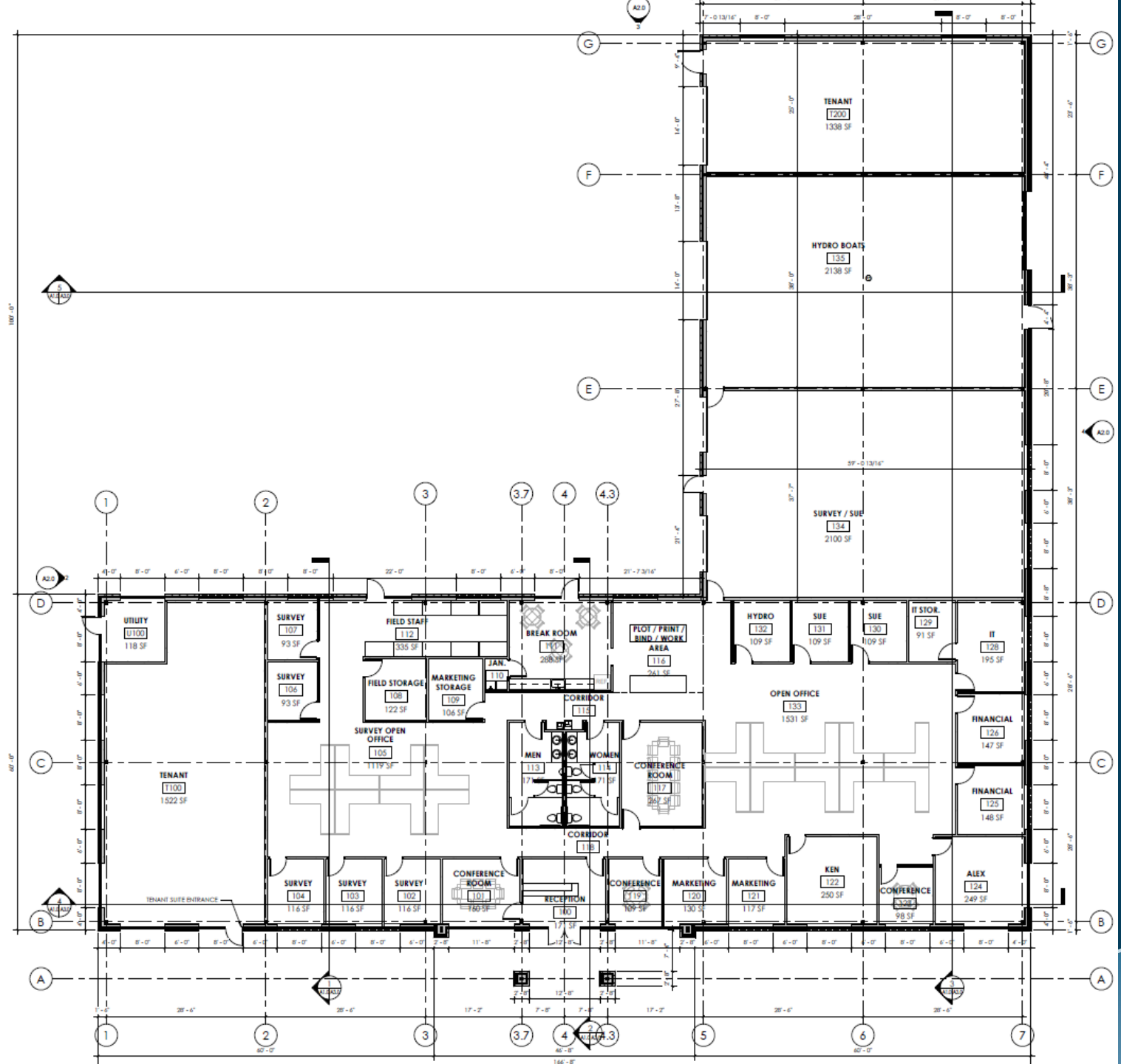
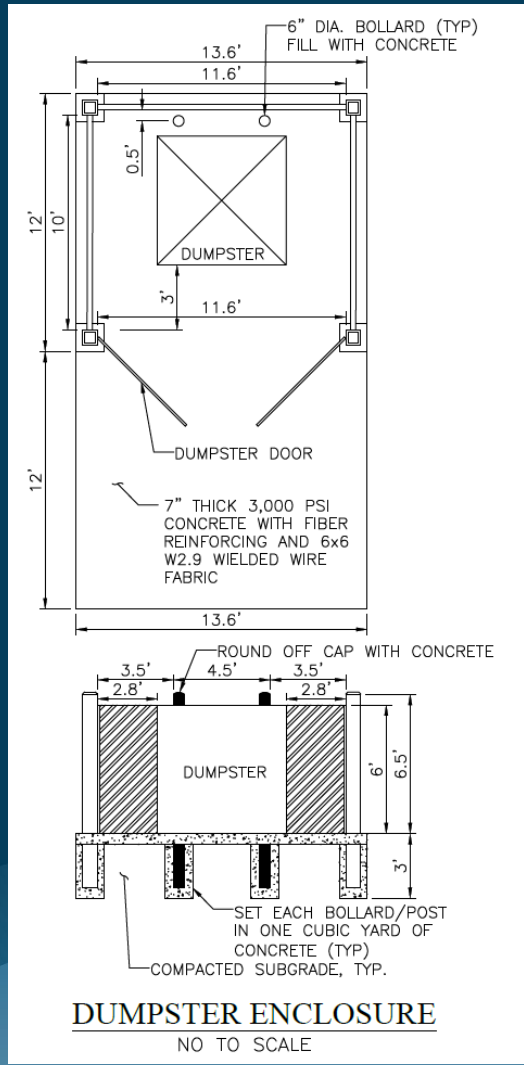

# Front and Left Elevations

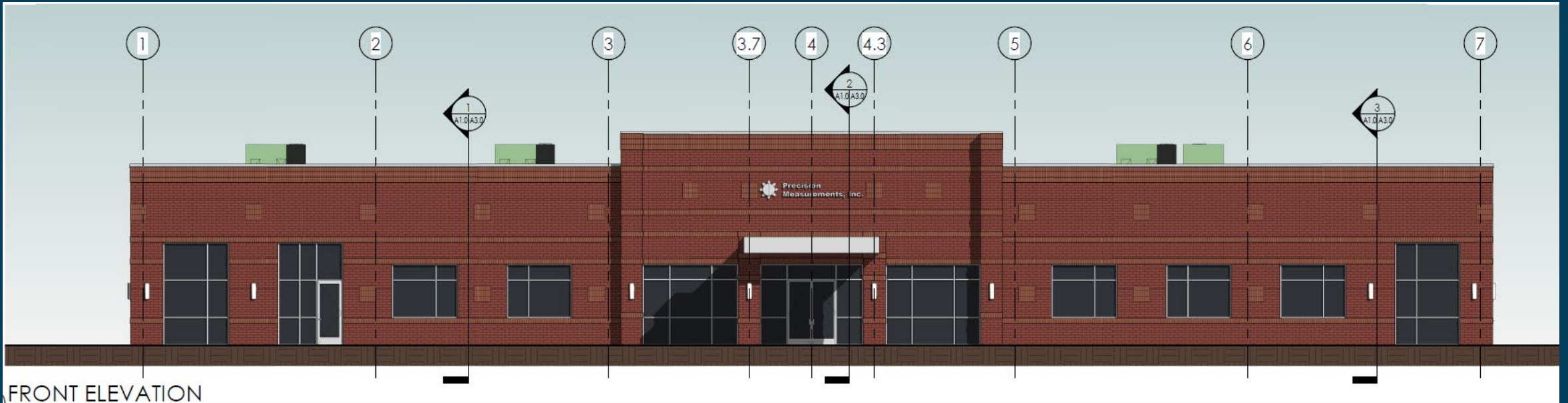

FRONT ELEVATION

1/8" = 1'-0"

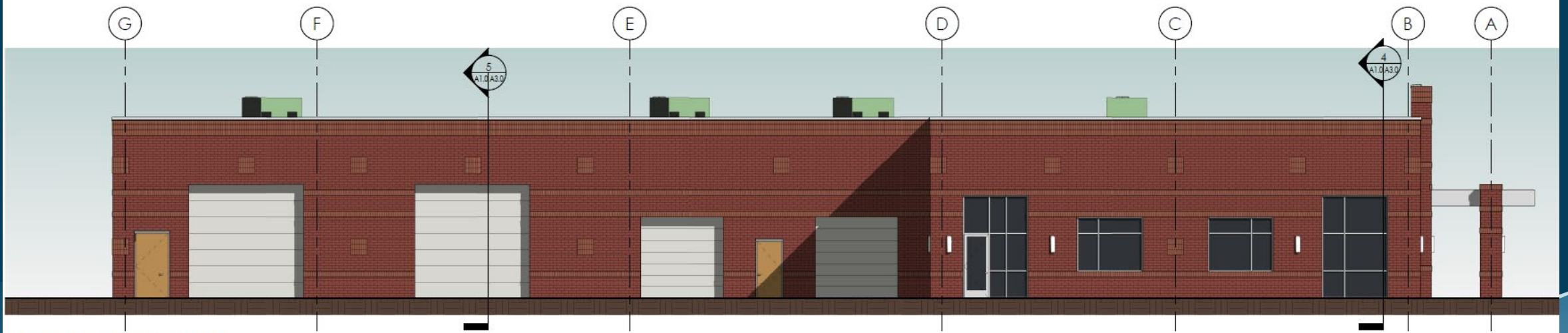

LEFT SIDE ELEVATION

1/8" = 1'-0"

# Rear and Right Elevations

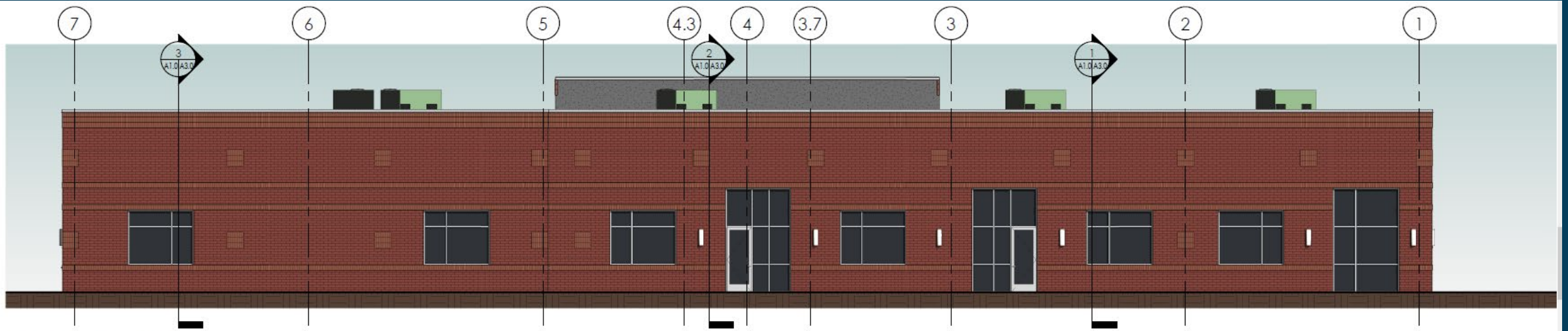

REAR ELEVATION

1/8" = 1'-0"

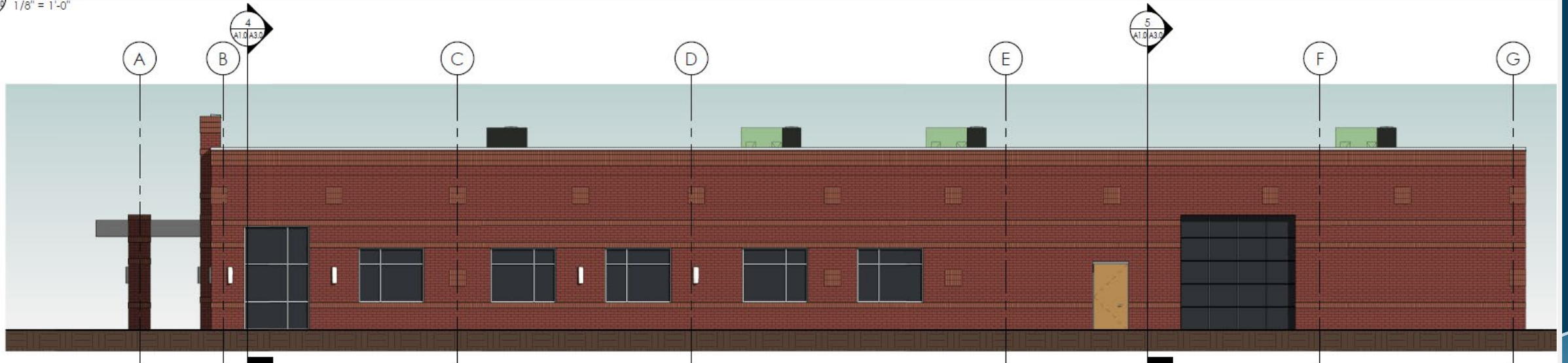

RIGHT SIDE ELEVATION

1/8" = 1'-0"



# Recommendation for Approval

- Designs, with exception of dumpster enclosure, meets the Corporate Landing Design Criteria
- Site plan has received conditional approval from DSC
- Construction anticipated this spring



3D VIEW



3D VIEW

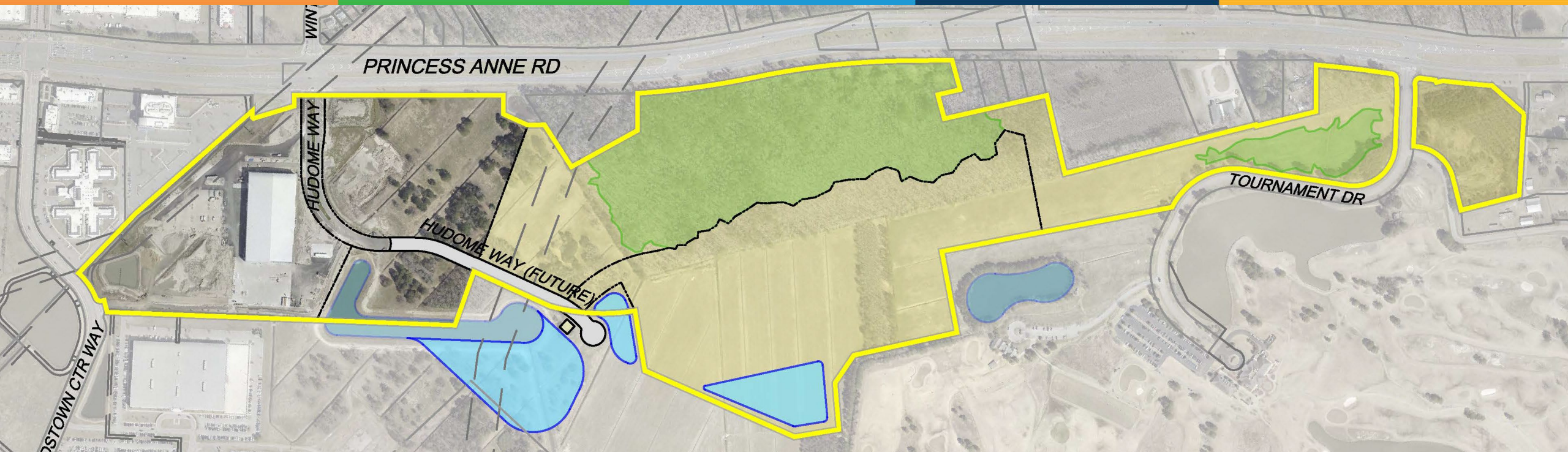

# INNOVATION PARK DESIGN & DEVELOPMENT GUIDELINES UPDATE

EMILY ARCHER, PLA  
VBDA | FEBRUARY 21, 2023

# THE VIRGINIA BEACH INNOVATION PARK BACKGROUND

- 150-acre conveyance to VBDA on April 5, 2016 to promote the expansion of the biomedical and healthcare business in the City
- Existing Park Proffers and Design Guidelines: 2016



## 2014 Conceptual Park Master Plan

# WHAT HAS CHANGED

- The biomedical ecosystem in VA Beach needed a boost first
- The market has shifted in recent years to other industry sectors causing an expansion of the Park's focus to research, technology and manufacturing while still supporting the field of scientific innovations
- The density of the Park has also been influenced by the City's updated storm water requirements, requiring more land and stormwater management facilities to accommodate development



2017 ITA Plan Vision for the VA Beach Bio Park



## DESIGN AND DEVELOPMENT GUIDELINES



## PRINCESS ANNE COMMONS BIOMEDICAL PARK



November 2016



# WHY THIS IS NEEDED

A modification is needed to remain relevant to the current and future market opportunities and:

- Reduce redundancy with the Zoning Ordinance and better align the document with current code requirements
- Assist property owners and developers regarding the appropriate site and building design
- Permit more flexibility with new and innovative materials and construction methods
- Harmonize and enhance the visual appeal of the Park developments



# INNOVATION PARK

DESIGN AND DEVELOPMENT  
GUIDELINES

## SUMMARY OF CHANGES - OVERALL

- Name Change from “Princess Anne Commons Biomedical Park” to the “Innovation Park”
- Imagery, maps & document design - New and updated photos, maps and layout to better illustrate the current developments in Princess Anne Commons and create a more user-friendly, visually compelling and organized document
- Review by VBDA section added to clarify and provide guidance on the approval process for developers and staff alike

# SUMMARY OF CHANGES – SITE DESIGN

- Landscape and Plantings: Edited for clarity and consistency with what is expected above and beyond the City of Virginia Beach's Landscape Ordinance; Appendix A was incorporated
- New Fencing Section: Fencing should be limited to side and rear yards and coupled with planting. Metal fencing with neutral color is preferred
- New Outdoor Amenity Areas section: court yards, break areas, patios are encouraged
- New Signage section: Signage must comply with and exceed the City's sign regulations

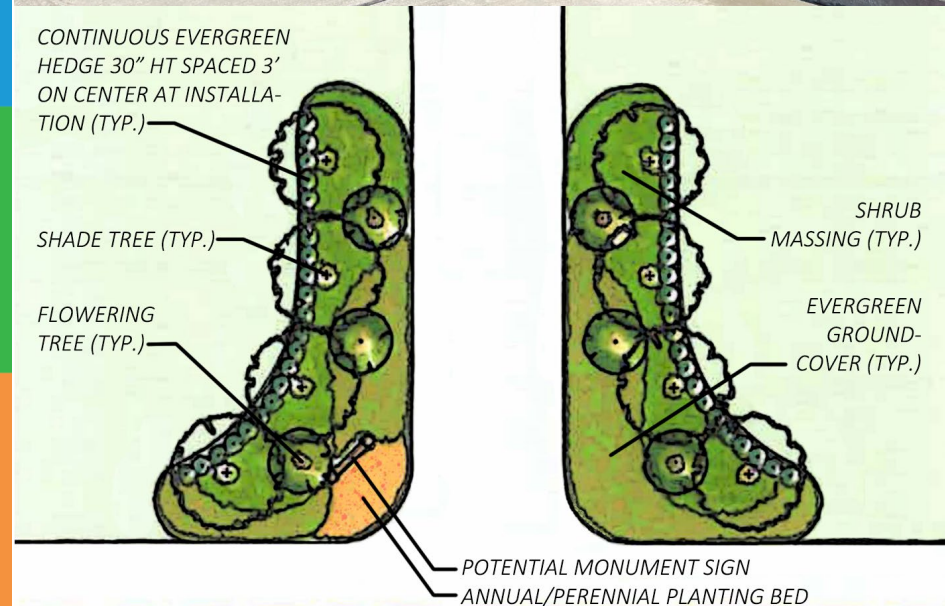



# SUMMARY OF CHANGES – BUILDING DESIGN

- Updated contemporary and light industrial/advanced manufacturing examples included
- New Exterior Materials and Palette: high quality, durable, aesthetically pleasing, and sustainable
- New Outdoor Storage, Staging & Service Area section: permitted, but must be in the rear and screened year round
- Removed Parking Structures section: Density within the Innovation Park is not anticipated to require a parking structure





# EXISTING OWNER COMMUNICATIONS

- In January a letter was sent to the two non-VBDA owners explaining the update and giving them the opportunity to be a party to this application
- YCH, LLC requested to be a co-applicant, the other owner was not interested and will follow the former Design Guidelines

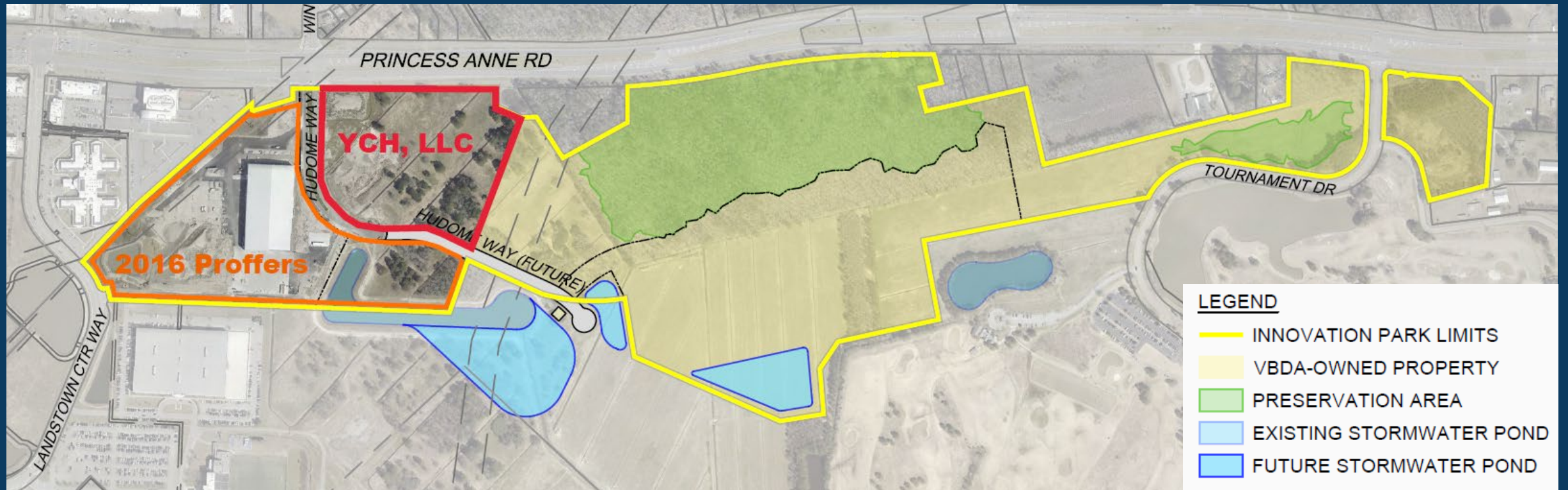

# SCHEDULE

Communication to existing owners:	January 10, 2023
Signs are posted around the Park:	February 3, 2023
VBDA:	February 21, 2023
TA/ITA Committee Meeting:	March 2, 2023
Planning Commission:	March 8, 2023
City Council:	April 4, 2023, or April 18, 2023

**Innovation Park Design Guideline update  
is recommended for VBDA's approval**

**OK to proceed?**

# THE VIRGINIA BEACH INNOVATION PARK BACKGROUND



2017 ITA Plan Vision for the VA Beach Bio Park

## 2017 ITA Plan Park Vision

- Regional trail network to be incorporated throughout park
- Wooded area adjacent to Princess Anne Road to be preserved
- Development to be consistent with The 2016 Princess Anne Commons Design and Development Guidelines
- Park to incorporate stormwater best practices and incorporate low-impact development principles



# Prufrex EDIP Recommendation

City of Virginia Beach Development Authority

February 21, 2023 | Open Session

*Laura Chalk, Deputy Director*

# Disclosures

- Applicant Name: Prufrex USA Inc.
- Officers: Kurt Mueller, Elke Kuhlmann-Mueller, Mark Ryan, Alfred Pretzl, Alexandro Lam
- Parent-Subsidiary: Prufrex Innovation Power Products GmbH, PRUFREX Engineering e Motion GmbH & Co. KG

# Company Overview

- German-based manufacturers of electronic ignition devices
- In 2013, moved U.S. Headquarters from Gainesville, GA
- Located at 2573 Quality Ct., Virginia Beach, VA 24354
- Original Project Numbers:
  - Capital Investment - \$7,330,000
  - Jobs - 60
  - Wage - \$44,240
- 2013 - Awarded \$120,000 EDIP
- 2020 - Awarded \$120,000 EDIP
  - Total of \$240,000



# Current Status

	Original Project Numbers	January 2023 Actual Numbers
Capital Investment	\$7,330,000	\$5,874,293
Jobs	60	50
Wage	\$44,240	\$54,645

Based on current project numbers, project qualifies for \$384,972 under EDIP Part A



# Recommendation

Close EDIP

Capital Investment of \$5,874,293 and 50 new jobs deemed sufficient to satisfy the performance criteria 2020 EDIP Award



# QUESTIONS



# **SANJO Retention Miller Group Land Swap**

City of Virginia Beach Development Authority

February 21, 2023 | Open Session

*Laura Chalk, Deputy Director*

# Disclosures: SANJO

- Accounting: Ecountable/Wall, Einhorn & Chernitzer
- Architect/Construction/Engineers: The Miller Group
- Financing: Wells Fargo
- Legal Services: Kaufman and Canoles, P.C.

# Disclosures: Miller Group

- Accounting: Wall Einhorn & Chernitzer, P.C.
- Finance: Towne Bank
- Architect: Covington Hendricks Anderson Architects
- Construction: Balicore, LLC
- Legal Services: Faggert & Frieden, P.C.
- Engineer: Kimley-Horn

# Overview

- SANJO retention effort
- Miller Group prepared to move forward with developing Lot 2
- SANJO still wants Lot 2 held for their future expansions, as well as a 5.4% lease rate based on developmental costs
- To hold a 5.4% lease rate, a \$900,000 gap in developmental costs needed to be closed

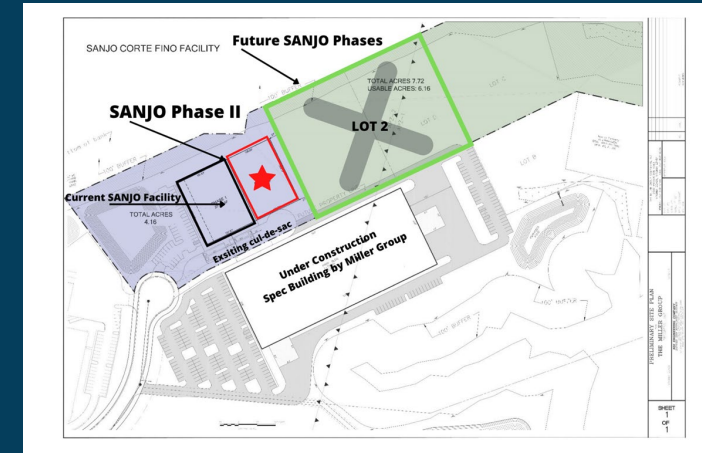

## VBDA Adopted resolution in July 2022

- Miller Group and VBDA agreed to land swap, with the difference made up as follows:
  - Cash contribution by Miller Group to VBDA of \$348,000
  - Remaining \$900,000 value differential applied to cost of construction for SANJO Phase II
  - Value differential got SANJO economically viable lease rate

# Land Swap Overview

## Original Maps

Progress Lane – 6.16 useable ac.

Corporate Landing – 12.4 ac

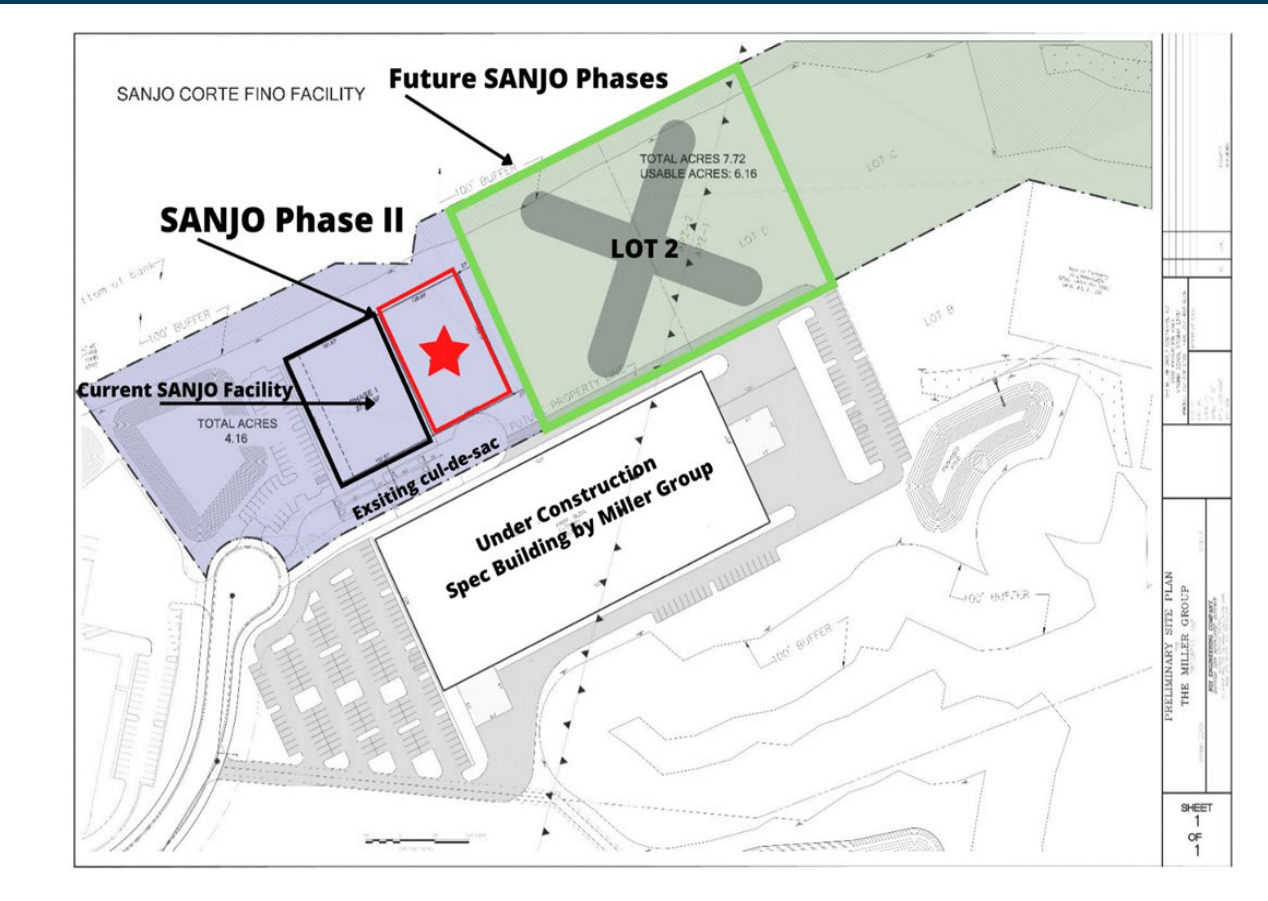

# Corporate Landing

Kimley Horn



# VHB





# Corporate Landing

## Progress Lane

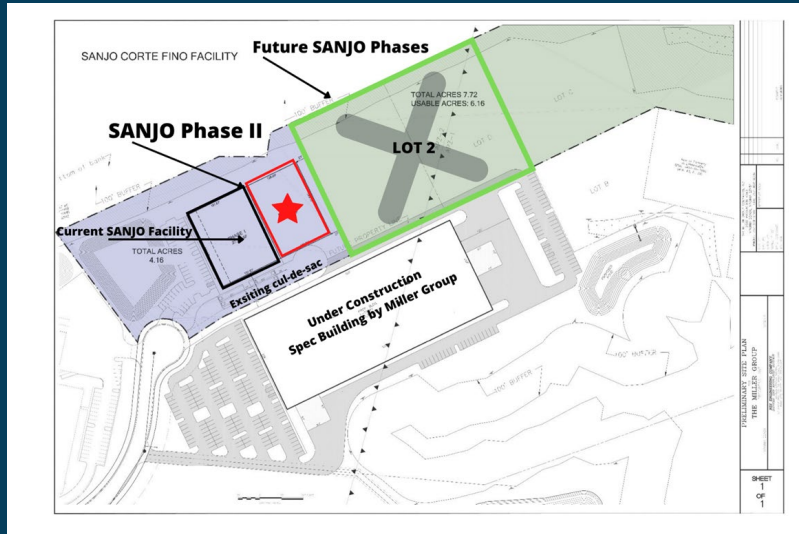

Progress Lane – Lot 2	JULY 2022
ACREAGE	6.16
VALUE	\$ 200,000
TOTAL:	\$ 1,232,000

## Kimley Horn



Corporate Landing - KH	JULY 2022
ACREAGE	12.4
VALUE	\$ 200,000
TOTAL:	\$ 2,489,000

## VHB



Corporate Landing - VHB	JANUARY 2023
ACREAGE	10.4
VALUE	\$ 200,000
TOTAL:	\$ 2,080,000

# Valuation Variance Difference

## Kimley Horn

ORIGINAL VARIANCE	JULY 2022
VARIANCE	\$ 1,248,000
To Be Applied to Development	\$ 900,000
Miller Group Responsibility	\$ 348,000

## VHB

ACTUAL VARIANCE	JANUARY 2023
VARIANCE	\$ 848,000
To Be Applied to Development	\$ 900,000
Value Gap	- \$ 52,000

# Proposed Solution

- To achieve \$900,000 value towards development costs
  - Proposed cash neutral transaction to fill the \$52,000 gap consisting of

SERVICES	COST
Topo Survey	\$ 18,000
Geotech	Up to \$ 30,000
BMP Sand Sale	At discount



# QUESTIONS



**ACTUALTIC**  
bringing actual technology

# Actualtic International Incubator

City of Virginia Beach Development Authority

February 21, 2023 | Open Session

*Paige Fox, Business Development Manager*

**VIRGINIA BEACH**  
DEVELOPMENT AUTHORITY

# Disclosures (Applicant)

- Applicant – Actualtic S.L.
- Principals: Margarida Guasch-Serrano, Pere Cardenas Moya
- Legal Services: Wilcox & Savage, P.C.

# Company Profile

- Engineering company specialized in technological diagnosis, ICT projects design and support services for procurement of technologies
- Based in Barcelona, Spain
- Member of PIMEC, first introduced during June 2022 Mission
- Part of PIMEC Delegation to Virginia Beach in September 2022



# International Incubator

- VBDA approved 1st tenant in September 2021
- Incentive for business looking to locate in United States
- Most international businesses begin with a smaller US sales office, before growing to distribution and large operations
- Meant for companies only needing 1 – 2 offices

**VIRGINIA BEACH**  
ECONOMIC DEVELOPMENT

## INTERNATIONAL INCUBATOR

### TEMPORARY OFFICE SPACE FOR A SOFT LANDING

The Virginia Beach International Incubator is geared towards international companies that need space to get their operations off the ground and grow their sales volume before establishing their own office or manufacturing facility in the City. The Incubator is strategically located in the Town Center of Virginia Beach adjacent to the Economic Development office.

**WHAT**  
Class A office space with shared conference room.

**WHO**  
Perfect for international companies needing 1-2 offices.

**WHERE**  
Located in the heart of the City's Central Business District.

[MORE INFO ON BACK](#)



# Sublease Terms

- 1<sup>st</sup> Virtual Tenant
- Maximum 2 Years Lease
- U.S. Mailing Address
- Access to Conference Room with 72-hour notice
- Payment Structure based on comparative pricing
  - Months 1 - 6: N/A (no rent)
  - Months 7 - 12: (\$65/ month)
  - Months 13 - 18: (\$95/ month)
  - Months: 19 - 24: (\$95 / month)



# Recommendation

- ✓ Approve sublease of Authority's International Incubator space to Actualtic



**ACTUALTIC**  
bringing actual technology

**QUESTIONS**



**KOREA AUTOMOBILE PARTS ASSOCIATION**



사단 한국자동차부품협회  
법인 Korea Automobile Parts Association

**KAPA Global Inc.**

(Korean Auto Parts Association)

**International Lease Incubator Recommendation**

City of Virginia Beach Development Authority

February 21, 2023 | Open Session

*Letitia Langaster, Business Development Manager*



# Disclosures (Applicant)

- Company: KAPA Global Inc., Seoul, Korea
- Property: 4525 Main Street, Ste. 710, Virginia Beach, VA
- Property Owners: Divaris/ Armada Hoffler

# Company Profile

- Korean Association representing the auto parts sector was established in 2015.
- Looking to establish US Headquarters in Virginia Beach as soon as possible.
- VBED staff has been working with KAPA Global over the past 3 years.
- KAPA team and Dept. of Economic team met November 3, 2022, and toured the International Incubator and HIVE for future transition office to US.

# Company Profile

- KAPA Global intends to open a small sales/administrative office with the view toward expanding Korean auto parts companies into the U.S. market.
- Distribution and manufacturing facilities are planned by Korean companies once success is achieved.
- Virginia Beach was chosen due to its proximity and access to The Port of Virginia and regional workforce pool.

# KAPA Expansion Plan

- Phase I: Secure Business License, and open international office in Virginia Beach, VA.
- Phase II: Open warehouse distribution center, stock inventory, and establish nationwide delivery system.
- Phase III: Establish a testing laboratory and assembly/manufacturing facility.



# International Incubator

- VBDA approved 1st tenant in September 2021
- Incentive for business looking to locate in United States
- Most international businesses begin with a smaller US sales office, before growing to distribution and large operations
- Meant for companies only needing 1 – 2 offices

**VIRGINIA BEACH**  
ECONOMIC DEVELOPMENT

## INTERNATIONAL INCUBATOR

### TEMPORARY OFFICE SPACE FOR A SOFT LANDING

The Virginia Beach International Incubator is geared towards international companies that need space to get their operations off the ground and grow their sales volume before establishing their own office or manufacturing facility in the City. The Incubator is strategically located in the Town Center of Virginia Beach adjacent to the Economic Development office.

**WHAT**  
Class A office space with shared conference room.

**WHO**  
Perfect for international companies needing 1-2 offices.

**WHERE**  
Located in the heart of the City's Central Business District.

[MORE INFO ON BACK](#)

# Incubator Lease Terms

- Maximum 2 years
- Access to Conference Room
- Private Entrance
- One office totaling approximately 200 square feet
  - Months 1 – 6: N/A (no rent)
  - Months 7-12: \$7.25 / sq. ft. = \$1,450 / year (\$120.83/ month)
  - Months 13-18: \$14.50 / sq. ft. = \$2,900 / year (\$241.66 / month)
  - Months: 19-24: \$20.25 / sq. ft. = \$4,050 / year (\$337.50 / month)



# Recommendation

- Approve sublease of Authority's International Incubator space to KAPA.



**KOREA AUTOMOBILE PARTS ASSOCIATION**



사단 한국자동차부품협회  
법인 Korea Automobile Parts Association

**QUESTIONS**